

UBOX RSH aktiv

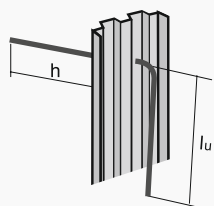

Ubox RSH aktiv



Tüüp S1

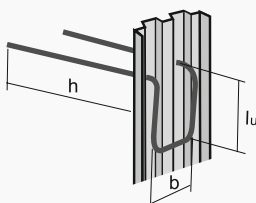

Tüüp S2

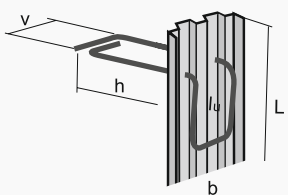

Tüüp S3

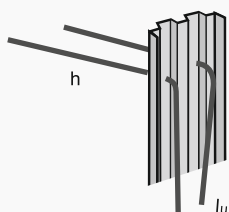

Tüüp S4

Ubox RSH aktiv - element on mõlemalt poolt kaetud vee toimel paisuva bentoniitribaga. Bentoniiti katab iselahustuv kile, mis kaitseb seda enneaegse paisumise eest.

Kasutusvaldkond:

- veekanalid
- mahutite veekindlad seinad
- plaatide ja seinte veekindlad ühendused

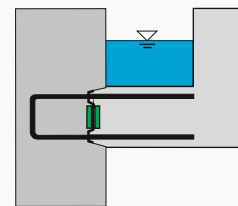

Kasutuskeem

Iseloomustus

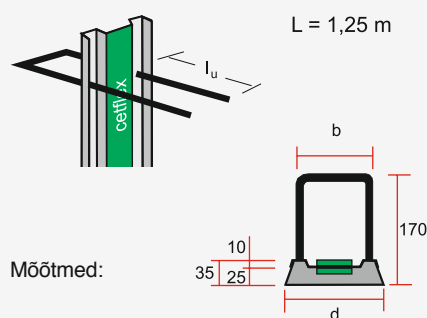

Mõõtmed:

Bentoniidiga kaetud Ubox RSH

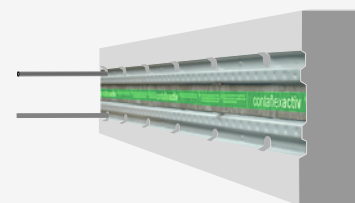

NB! Kaitsekilet ei tohi eemaldada.

Ubox RSH tehnilised andmed

Toote number	Tüüp	b, cm	Terase Ø, mm	a, cm	h, cm	d, cm	L, m	lu, cm
574-0815	RSH 14-8-15 aktiv	14	8	15	17	17	1,25	30
574-0820	RSH 14-8-20 aktiv	14	8	20	17	17	1,25	30
574-1015	RSH 14-10-15 aktiv	14	10	15	17	17	1,25	38
574-1020	RSH 14-10-20 aktiv	14	10	20	17	17	1,25	38
574-1215	RSH 14-12-15 aktiv	14	12	15	17	17	1,25	45
574-1220	RSH 14-12-20 aktiv	14	12	20	17	17	1,25	45
576-0815	RSH 16-8-15 aktiv	16	8	15	17	19	1,25	30
576-0820	RSH 16-8-20 aktiv	16	8	20	17	19	1,25	30
576-1015	RSH 16-10-15 aktiv	16	10	15	17	19	1,25	38
576-1020	RSH 16-10-20 aktiv	16	10	20	17	19	1,25	38
576-1215	RSH 16-12-15 aktiv	16	12	15	17	19	1,25	45
576-1220	RSH 16-12-20 aktiv	16	12	20	17	19	1,25	45
578-0815	RSH 18-8-15 aktiv	18	8	15	17	21	1,25	30
578-0820	RSH 18-8-20 aktiv	18	8	20	17	21	1,25	30
578-1015	RSH 18-10-15 aktiv	18	10	15	17	21	1,25	38
578-1020	RSH 18-10-20 aktiv	18	10	20	17	21	1,25	38
578-1215	RSH 18-12-15 aktiv	18	12	15	17	21	1,25	45
578-1220	RSH 18-12-20 aktiv	18	12	20	17	21	1,25	45
570-0815	RSH 20-8-15 aktiv	20	8	15	17	23	1,25	30
570-0820	RSH 20-8-20 aktiv	20	8	20	17	23	1,25	30
570-1015	RSH 20-10-15 aktiv	20	10	15	17	23	1,25	38
570-1020	RSH 20-10-20 aktiv	20	10	20	17	23	1,25	38
570-1215	RSH 20-12-15 aktiv	20	12	15	17	23	1,25	45
570-1220	RSH 20-12-20 aktiv	20	12	20	17	23	1,25	45
572-0815	RSH 22-8-15 aktiv	22	8	15	17	25	1,25	30
572-0820	RSH 22-8-20 aktiv	22	8	20	17	25	1,25	30
572-1015	RSH 22-10-15 aktiv	22	10	15	17	25	1,25	38
572-1020	RSH 22-10-20 aktiv	22	10	20	17	25	1,25	38
572-1215	RSH 22-12-15 aktiv	22	12	15	17	25	1,25	45
572-1220	RSH 22-12-20 aktiv	22	12	20	17	25	1,25	45