

FORMAX 1000 C

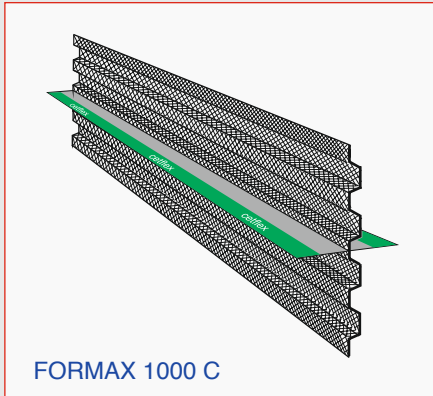

Formax 1000 C on mitte-eemaldatava raketise ja tihendusprofiili Cetflex ühendusprofiil.

Formax 1000 C kasutatakse betoonplaatide töövuukide raketisena, kui töövuugis kasutatakse aktiivbentoniidiga kaetud Cetflex veetõkke vuugiprofiili.

Profiilil puudub oma toetus.

Formax 1000 C on Eurocode 2 kohaselt töövuukide kõrgeim kategooria.

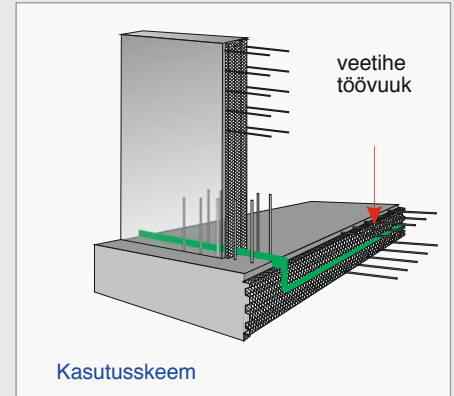

Süsteemi kirjeldus

Ühendusvariandid

Variant A ilma varuta

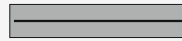

Variant A ühepoolne varu



Variant C kahepoolne varu



Variant D sisselõige ja sulund



Järgmiste lõikude ühendamine:

Varu 10 cm

Paisuv bentoniit tihendab korralikult ühenduskoha.

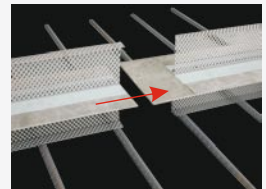

Jätkuvad profiilid kinnitatakse klambritega KA 18/3.

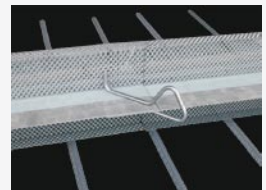

Profiili kuju

Kasutatavad profiilide kujud olenevalt raudbetoonplaadi paksusest:

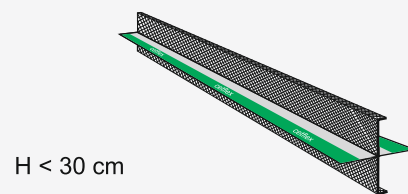

Kõrguse H > 30 cm puhul on Formax hambulise profiiliga.

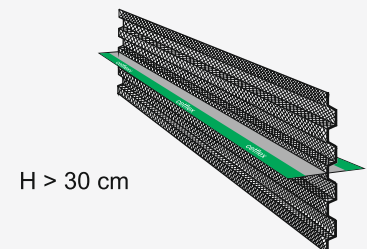

Formax 1000 C tehnilised andmed

Toote number	Tüüp	Pikkus, m	Võrgu paksus, mm	Profiili laius, mm	Profiili paksus, mm
704-...	Formax 1000 C/0,70	2,25	0,70	200	1 1,50 2,0
704-...	Formax 1000 C/1,25	2,25	1,25	200	1 1,50 2,0
704-...	Formax 1000 C/1,50	2,25	1,50	200	1 1,50 2,0

Profiili kõrgus H: tellimuse järgi